



SURGE PROTECTION SOLUTIONS

SURGE-TRAP®
IEC TYPE 1,
1+2, 2, 2+3
LIGHTNING
AND SURGE
PROTECTION



BS 7671
The 18th Edition
2018



INDEX

• Why Mersen? _____	3	• Products: Surge-Trap®	
• Introduction to surge protection _____	4	Type 1+2 _____	14
• SPD features based on the IEC 61643 Standard _____	6	Type 2 _____	16
• Typical Current (I_{TYP}), beyond the Standard _____	7	Type 2+3 _____	18
• BS 7671:2018 / 18 th edition _____	8	• Selection guide _____	20
• SPD placement in your design _____	9	• SPD general installation features _____	22
• Surge-Trap® highlights _____	12		

WHY MERSEN?

Expertise in power quality

Your global electrical power partner

Mersen is a leading market player with innovative solutions in the field of lightning and surge protection.

We design, manufacture, test and certify our products and your systems.

Safety & reliability for surge protection

- **Bringing together the experience** of the principal international **manufacturing and test standards** for SPDs (IEC and UL)
- **Unique expertise in the combination of SPD and fuse technology**, one of the hot topics in the SPD industry
- **Innovative ranges combining surge protection and ground monitoring** to provide full safety and continuity of service
- **World-class surge test platform**, with laboratories holding accreditations for both IEC/EN 61643-11 (Terrassa) and UL 1449 3rd ed (Newburyport)
- **Global manufacturing footprint** of a comprehensive range of solutions covering both IEC and UL markets
- **Leadership in POP (TOV)** (Power-frequency Overvoltage Protection) and combined **SPD+POP** devices. EN 50550.
- Wide range of solutions targeting **industrial, commercial and residential applications**

World-class surge test platform

Mersen is committed to **innovation**. The proof of that quest for continual improvement: a total of more than a million tests in 25 years!

In the field of lightning and surge protection Mersen has a highly specialised team, test laboratories, high investment in R&D&i, international patents and presence on standards committees.

Mersen has two surge test labs: one in Newburyport, Massachusetts, and one state of the art Lightning and Surge protection test lab in Terrassa, Spain, namely the Global Center of Excellence for IEC Surge Protection. The two are complementary, in terms of the available resources, to be able to offer the **widest possible range of tests to IEC, UL and NFC standards**.

Lightning and surge protection

Mersen offers a wide range of solutions along with advice and consulting services as well as after sale service

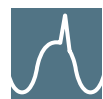

SPD – Surge-Trap®
Surge protective devices to IEC and NEMA/UL.
Also for telecom and signalling networks.



GND – Grounding system monitors.



POP (TOV) – Power-frequency Overvoltage Protection.
EN 50550. (Temporary Overvoltages TOV)



ESE – Electronic Early Streamer Emission lightning air terminals.



Mersen welcomes customers at both locations to run test campaigns focussed on critical points in their own bills of requirements



INTRODUCTION TO SURGE PROTECTION

What are surges?

Surges are transient over voltages that can reach tens of kilovolts with durations in the order of microseconds. Despite their short duration, the high energy content can cause serious problems to equipment connected to the line like premature aging of electronic components, equipment failure or disruptions to service and financial loss.

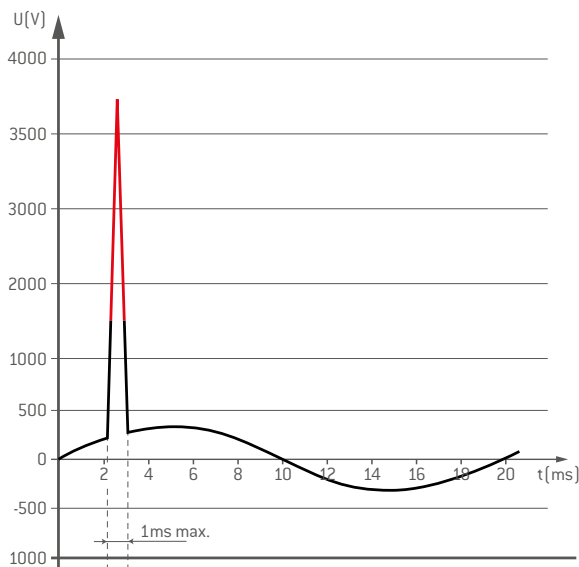

When the peak voltage reaches a value higher than the equipment can withstand, it causes its destruction.

Origin of surges

- Lightning:** The most destructive source of surge. Based on the IEC 61643-12 standard, energy from lightning can reach up to **200 kA**. However for reference, estimates indicate 65% are less than 20kA and 85% are less than 35kA.
- Induction:** Sources include cloud to cloud lightning or nearby lightning impacts where the current flow induces an overvoltage on supply lines or other metallic conductors.

There is no way of really knowing when, where, the size, or the duration/waveform of a surge. Therefore, within the Standards, some assumptions have been made and 2 main waveforms have been chosen to simulate different surge events.



Types of Surges

Conduction

Conduction or 10/350 μ s simulates energy from lightning direct impact

Induction

Induction or 8/20 μ s simulates energy from indirect lightning impact

Do not confuse this kA rating with the fault levels of the installation.

Fault ratings given by the transformer are kA for 1 second. Surge kA rates are for microseconds. Protection in front of surge will be based on this statement.

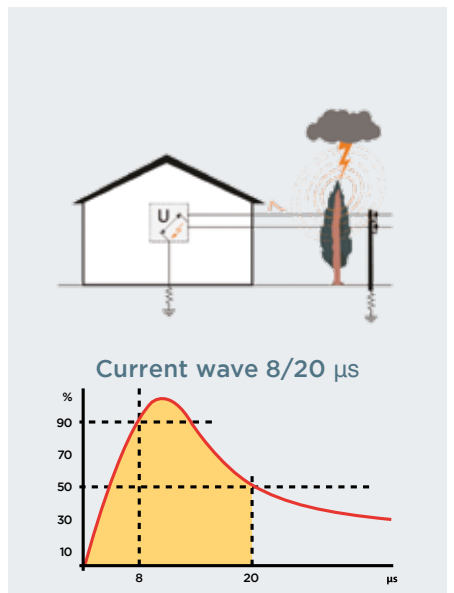
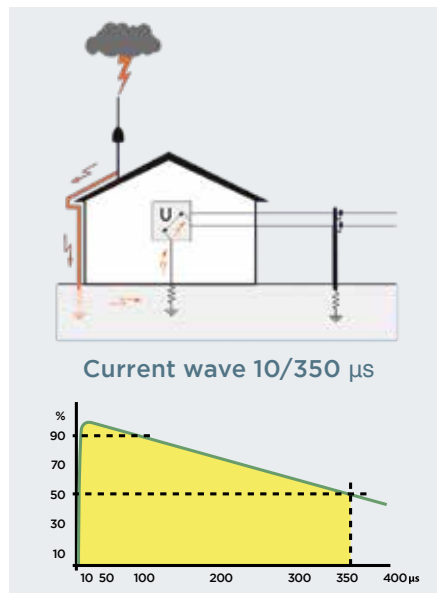

Internal sources:

These are the main sources of surge in real life

They come from utility grid switching, disconnection of motors or other inductive loads. Energy from these sources is also analysed with the 8/20 μ s wave form.

Transient overvoltages do not occur solely in power distribution lines, they are also common in any line formed by metal conductors, such as telephony, communications, measurement and data.

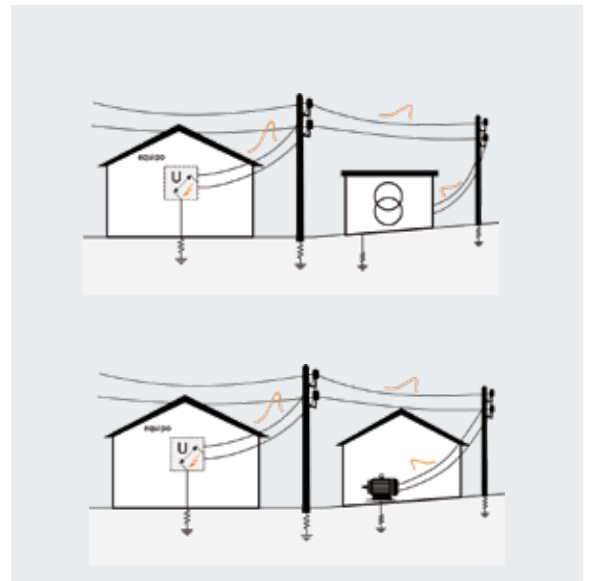

Protector in front of surges: SPD (Surge Protection Device)

A transient overvoltage protection device acts as a voltage controlled switch and is installed between the active conductors and ground in parallel with the equipment to be protected. When the supply voltage is lower than its activation voltage, the protector acts as a high-impedance element so that no current flows through it. When the supply voltage is higher than the activation voltage, the protector acts as an element with impedance close to zero, diverting the over voltage to earth and preventing it from affecting equipment downstream.

Nevertheless, in the terminals of the SPD there will always be a residual voltage (U_{res}) which it is not a fixed rate. Because of the surge current, there will be a residual voltage across the SPD, that means higher surge current and higher residual voltage. To protect your electrical equipment the residual voltage across the SPD, including the wires and connections, needs to be less than the over voltage withstand of the equipment.

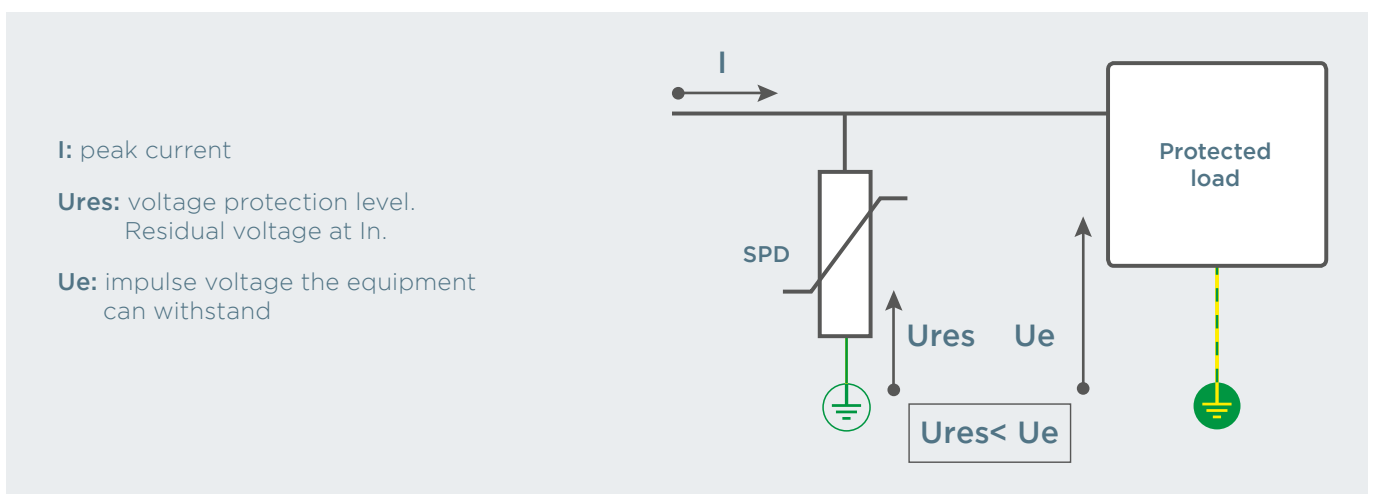

SPD FEATURES BASED ON THE IEC 61643 STANDARD

Protector parameters

Up

Voltage protection level

Maximum residual voltage between the terminals of the protection device during the application of a peak current.

In

Nominal current

Peak current in 8/20 μ s waveform the protection device can withstand 20 times without reaching end of life.

I_{max}

Maximum discharge current

Peak current with 8/20 μ s waveform which the protection device can withstand.

U_c

Maximum continuous operating Voltage

Maximum effective voltage that can be applied permanently to the terminals of the protection device.

I_{imp}

Impulse current

Peak current with 10/350 μ s waveform which the protection device can withstand without reaching end of life.

Classification of protectors

Protection devices are classified into types according to discharge capacity:

- **Type 1:**

Tested with a 10/350 μ s waveform (Class I test), which simulates the current produced by a direct lightning strike.

Ability to discharge very high currents to earth, providing a high Up - voltage protection level.

Must be accompanied by downstream Type 2 protectors. Designed for use in incoming power supply panels where the risk of lightning strike is high, for example in buildings with an external protection system.

- **Type 2:**

Tested with a 8/20 μ s waveform (Class II test), which simulates the current produced in the event of a switching or lightning strike on the distribution line or its vicinity.

Ability to discharge high currents to earth, providing a medium Up - voltage protection level. Designed for use in distribution panels located downstream of Type 1 protectors or in incoming power supply panels in areas with low exposure to lightning strikes.

- **Type 3:**

Tested with a combined 1.2/50 μ s - 8/20 μ s waveform (Class III test), which simulates the current and voltage that can reach the equipment to be protected.

Ability to discharge medium currents to earth, providing a low Up - voltage protection level. Always installed downstream of a Type 2 protection, it is designed to protect sensitive equipment or equipment located more than 20m downstream of the Type 2 device.

The technology can provide protection solutions that combine different types of protection: Type 1+2 and Type 2+3.



TYPICAL CURRENT (I_{TYP}), BEYOND THE STANDARD

Typical current (I_{typ}); SPD performance that guarantees the surge protection in the real life

I_{imp} , I_{max} and I_n show the one off maximum robustness of the SPDs in heavy conditions. However, most surge currents are in practice lower and repetitive because of network switching or because lightning inductions onto the power grid.

The Typical Surge Current (I_{typ}) is the value that statistically the SPD faces in real life. The value depends on the level of exposure:

High exposed locations

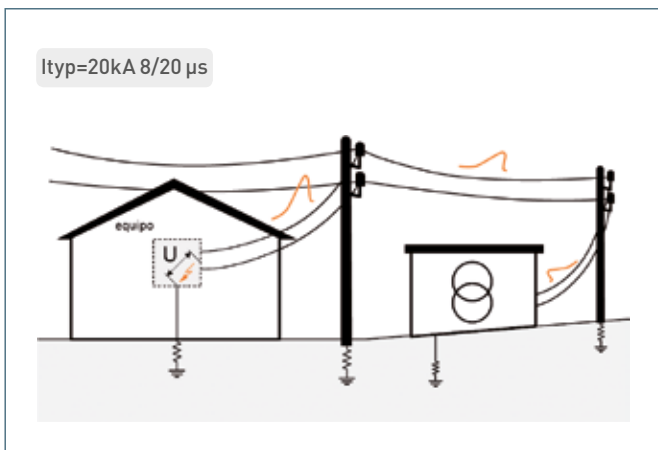

Low exposed locations or internal surges

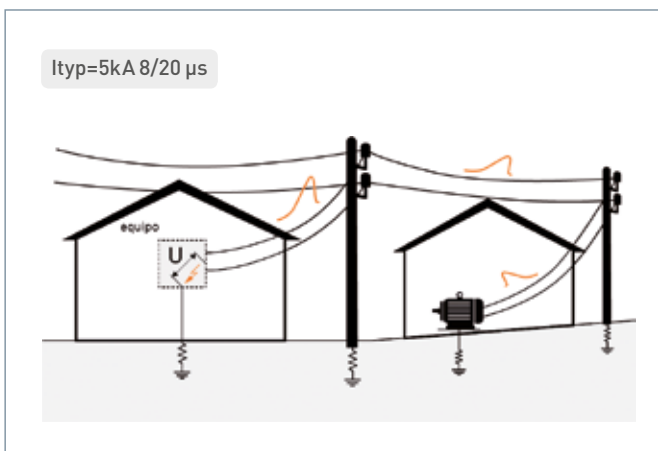

The lifetime is described by the number of hits that **the SPD is able to withstand at Typical Surge Current (I_{typ})**.

Lifetime of the SPDs: To estimate the lifetime of the SPD is a must in order to guarantee the protection. The **SPD must be designed in order to pass the test of the standards, but furthermore to guarantee a great performance in real life.**

The minimum lifetime value that we must ask for are:

- **HIGH EXPOSED LOCATIONS: 100-200 peaks.** Type 1+2 SPD requirement; usually installed in the highest exposed locations.
- **LOW EXPOSED LOCATIONS OR INTERNAL SURGES: 500 peaks** Type 2 SPD requirement; usually installed in medium or lower exposed locations.

A step ahead for surge protection

Posted 2nd July 2018 and effective from 1st January 2019, BS 7671 2018 supposes a big change for the surge protection in the UK.

On one side, the 18th Edition **opens the need for installing surge protection in a very broad spectrum from public, commercial or industrial activities too, even, consumer unit applications** depending on the circumstances. On a second side, the 18th Edition, (based on the EN 62305-4 and EN 61643-12) describes the selection and the application of surge protection devices too.

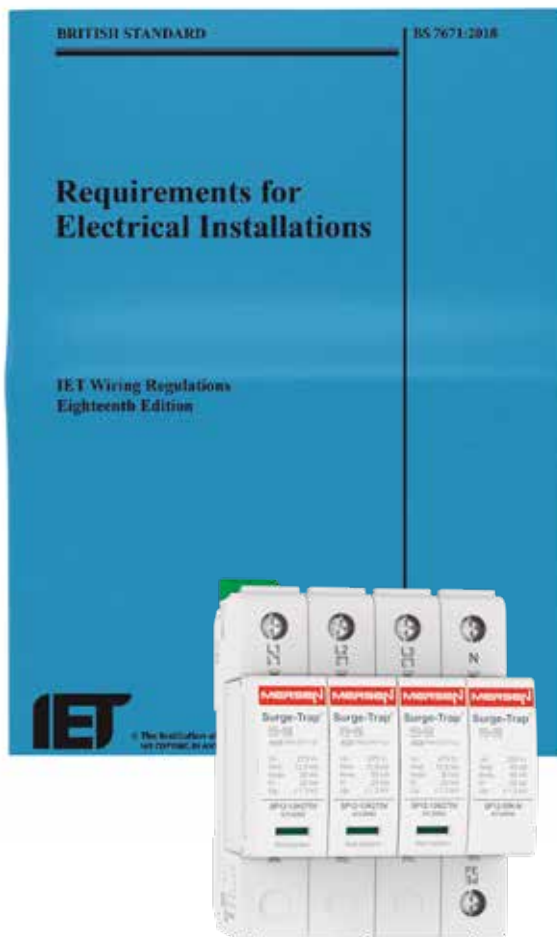

Where is surge protection required?

Section 443. Protection against transient overvoltages of atmospheric origin or due to switching states that protection against transient overvoltages shall be provided where the consequence caused by overvoltage could:

- Result in serious injury to, or loss of, human life, or
- Result in interruption of public services and/or damage to cultural heritage or,
- Result in interruption of commercial or industrial activity, or
- Affect a large number of co-located individuals.

For all other cases, a risk assessment according to Regulation 443.5 shall be performed in order to determine if protection against transient overvoltages is required. If the risk assessment is not performed, the electrical installation shall be provided with protection against transient overvoltages, except for single dwelling units where the total value of the installation and equipment therein does not justify such protection.

Protection against switching overvoltages shall be considered in case of equipment likely to produce switching overvoltages or disturbances exceeding the values according to the overvoltage category of the installation, e.g. where an LV generator supplies the installation or where inductive or capacitive loads (e.g. motors, transformers, capacitor banks), storage units or high-current loads are installed.

SPD PLACEMENT IN YOUR DESIGN

(BS7671 SECTION 534.4 "SELECTION AND INSTALLATION OF SPDs")

Which SPD has to be selected?

Section 534 describes the selection and installation of SPD

Where to start the protection design?

At the origin of the installation, the main switchboard is the place to start the design of SPDs on the network.

What is the SPD that has to be installed in the mains?

As stated in section 534.4 1.1, SPD installed at the origin of the installation shall be Type 1 or Type 2.

Type 1, Type 2 which one has to be selected?

As previously stated, the SPD protection design does not depend on the fault ratings given by the transformer, it only depends on the level of exposure in front of a surge. So, which SPD do we have to install in the main switchboard?

See the diagram below from IEC 63205-1 standard which displays the dispersion of the highest lightning considered: 200kA @ 10/350µs.

In the worst case scenario, 50% of this energy is conducted away to earth leaving 100kA potential across the networks 3 phase and neutral. Here a **25kA @ 10/350µs (Iimp) Type 1** SPD is recommended for insulated installations in extreme exposed locations to lightning.

In the "Normal Scenario" it is assumed any direct lightning strike to the network will be at such a distance from the installation that another 50% of the energy is dispersed to earth via other conductors before entering your point of connection. In this scenario a device with **12.5kA @ 10/350µs (Iimp) Type 1** is recommended. **Furthermore, based on the IEC 61643-12 standard and even stated in section 534.4, 12.5kA is the minimum kA rate when a Type 1 is needed.** If the level of exposure of the installation is lower than above described scenarios

Type 2 SPD (I_{max}) may be considered along with risk and cost of equipment and downtime.

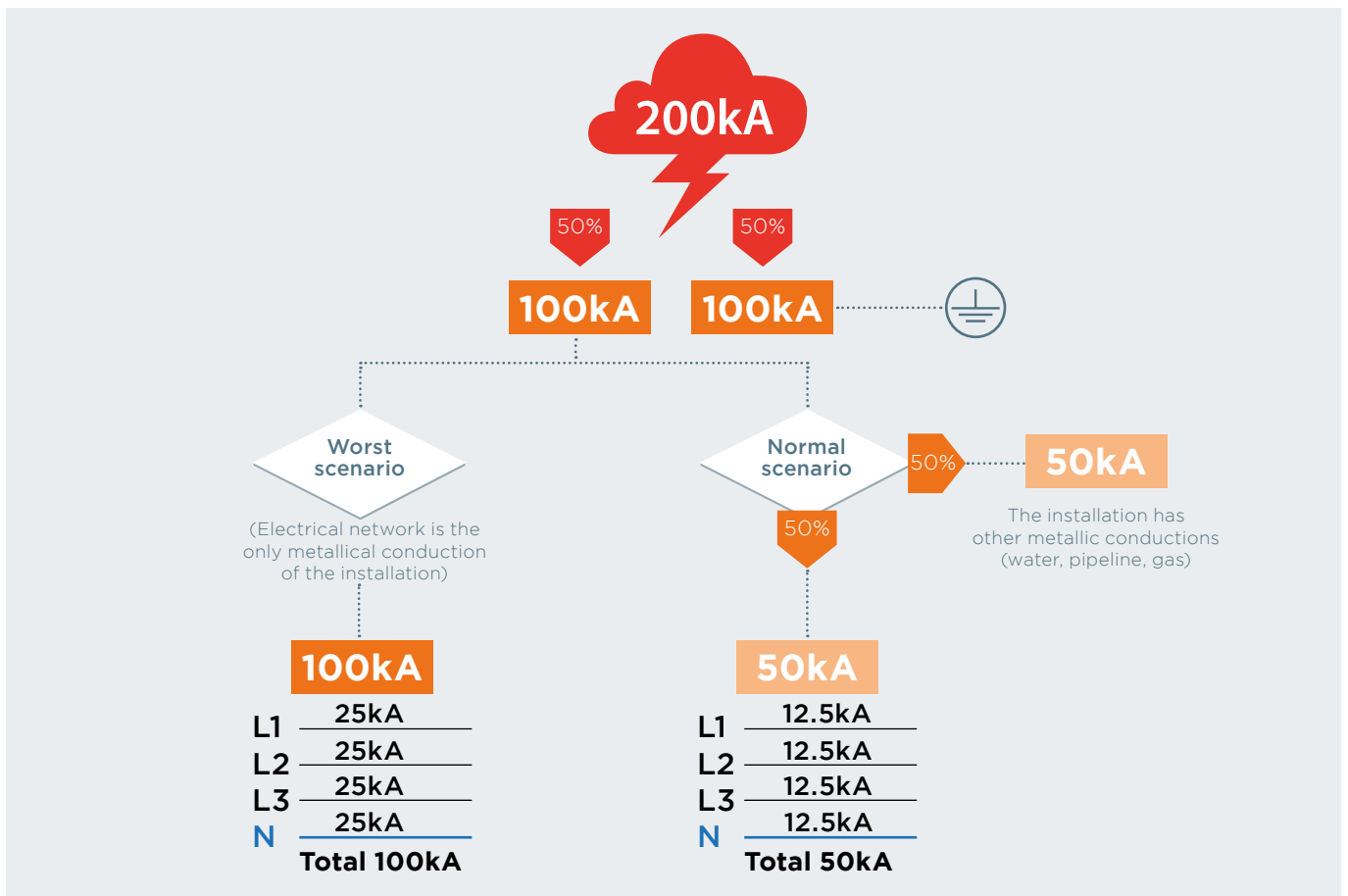



SPD PLACEMENT IN YOUR DESIGN

(BS7671 SECTION 534.4 "SELECTION AND INSTALLATION OF SPDs")

Do we have to consider more SPDs in the distribution boards?



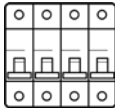





The IEC 60634-4-443 standard classifies electrical devices in categories, depending on how sensitive they are to the surge over voltage (Ue). Category 1 devices (electronic receivers) are the most sensitive, Ue has to

be at least 1.5 kV. Whereas category 4 devices can withstand 6kV or more. Generally, components in main switchboards are category 4 devices ie ACB, MCCB etc.

Category	IV	III	II	I
230/400 lines	Counters / MCCB / ACB	MCBs and RCCDs	Electrical devices	Electronic receivers
Example				
Impulse voltage withstand	6kV	6kV	2.5kV	1.5kV

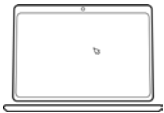
Then, let's consider an example below, where a Type 1+2 SPD is installed in the main distribution board of an installation. The following chart analysis, the status of

the SPD, the status of the category 1 loads (the most sensitive Ue: 1.5kV) in front of different surge scenarios:

		Surge example		
		≤25kA	100kA	10kA
Iimp = 25kA Imax = 100kA In = 25kA Up ≤ 1.5kV In accordance with the IEC 61643-11				
Ue = 1.5kV				

According to the IEC 61643-1 declared Up rate is related to In. Although the SPD is able to withstand Imax probably Up level will be higher than Ue.

Statements:

- 1 - For discharges over the maximum capacity (**I_{max}**) of the SPD, the loads and the SPD itself will be damaged.
- 2 - Iimp and I_{max} describe the maximum surge level the SPD itself can withstand but does not describe the protection
- 3 - Only **In** describes the level of protection as at **In** the residual voltage seen but the equipment being protection is Ue.
- 4 - As surges may be induced in cable between the main switchboard and distribution board, or by the final loads themselves, the switchboard may not be close enough to direct a surge in time to protect other final loads.

Conclusions:

- 1 - With just one stage of protection only equipment close to the SPD is protected and only up to a surge of In.
- 2 - To improve the protection possibilities, at least, a second stage of protection in a distribution board is a must. This SPD design is called cascading protection.

3.- Further SPDs (Type 2 and Type 3) are required to protect sensitive and critical equipment downstream of the origin of the installation when a Type 1 is fitted at the origin of installation (534.4.1.1)

Do we need to install a third stage of surge protection devices?

A third stage of surge protection installed at the final load may be considered depending on what load it is, how critical, expensive, cost of downtime and sensitive it is. If the cost of the equipment and/or downtime is high then installing a third stage Type 3 (1.5/50 μ s) device will further reduce the risk of any last surge energy getting to your equipment.

Examples of applications that should include a 3rd stage of surge protection are:

- Hospitals
- Data Centres
- Airports
- Banking and Insurance
- Transportation



SURGE-TRAP® HIGHLIGHTS

STP Surge-Trap® Pluggable

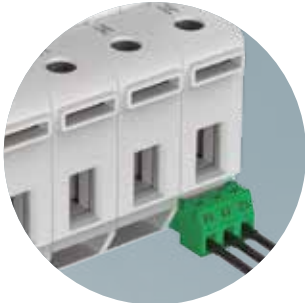

Remote indication

Dry contacts, optional in all ranges, for remote indication of protector end of life.



Biconnect connection

Two types of terminal: for rigid or flexible cable and for fork type comb busbar.



Mersen quality

Product range produced entirely by Mersen, with a thermal disconnection system. Use of the best materials and components. UL 1449 4th Ed.

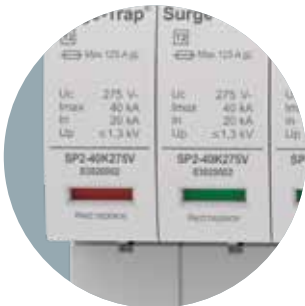

Protector lifetime status indication

Clear display of protection end of life.



Cartridge security system

Vibration proof according to the maximum levels specified in IEC 60721 (2M3 transport & 3M8 operation).

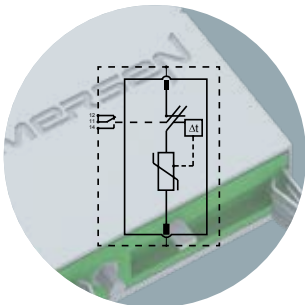

New, optimised disconnection system

Mersen has developed an optimised disconnection system for end of life. Complies with the disconnection tests of the standards for protectors for photovoltaic applications.

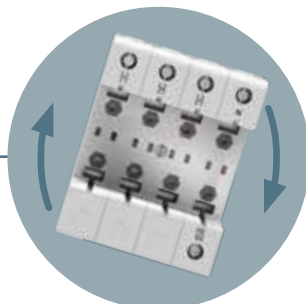

Reversible installation

Reversible chassis to allow cable entry from above or below.



Surge-Trap® TERRA

Monitoring the grounding system in the surge protection device itself.

THE BEST PERFORMANCE IN THE MARKET

STP T12 12.5

Combined Type 1+2 lightning current arrester and voltage surge protector

Ability to discharge lightning currents (10/350 μ s) and induced voltage surges (8/20 μ s)



Suitable as the first step of protection

Power supply panels.

Areas with exposure to the atmosphere

Where installations are usually provided with an external lightning protection

STP T2 40 TERRA

TERRA® is the first protection device on the market that, in addition to indicating that it is properly wired, guarantees that there is an adequate path to earth, which is essential if the protection device is to shunt the energy peaks to earth effectively.

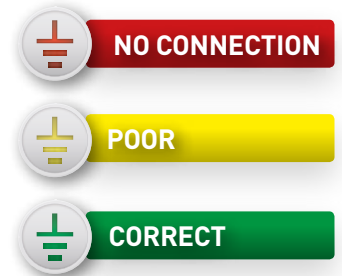

Earth status indicator

Continuous LED display of earth status

STE T23 EMI

EMI / RFI Filter

All models include an electromagnetic filter for network noise.

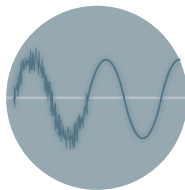

Combined SPD (Type 2+3)

Combined devices for discharging induced transient overvoltages, while providing a very fine protection level for sensitive equipment.

STM T23 SLIM

Status indication

Remote and visual indication of life status of the protection device.



Type 2+3, 2 poles in 1 module

Compact combined device (Type 2+3) for fine protection. Ideal for limited spaces.

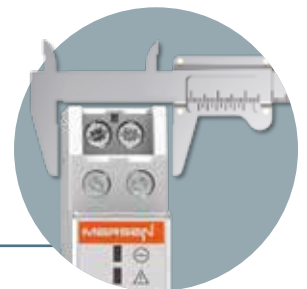

SURGE-TRAP® TYPE 1+2 SPDs | STP T12 12.5

STP T12 12.5

Dimensions

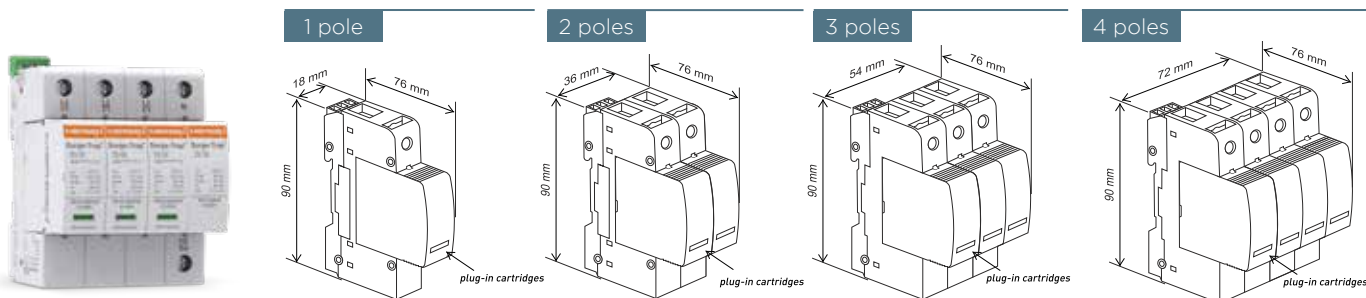

Catalogue numbers / Reference numbers

1 pole

REFERENCE NUMBER	CATALOGUE NUMBER	SYSTEM TYPE	Un [Vac]	Uc [V]	Iimp (10/350) [kA]	Imax (8/20) [kA]	In (8/20) [kA]	Up@In (8/20) [kV]	REMOTE (M)	Cartridge Id.	
										L	N
83120102	STPT12-12K275V-1P	L-N (1Ph)	230	275	12.5	50	20	≤1.3		C03	-
83120103	STPT12-12K275V-1PM	L-N (1Ph)	230	275	12.5	50	20	≤1.3	√	C03	-
83120108	STPT12-25K-N	N-PE (N)	Neutral	255	25	50	25	≤1.5		-	C06
83120110	STPT12-50K-N	N-PE (N)	Neutral	255	50	50	50	≤1.5		-	C07

2 poles

REFERENCE NUMBER	CATALOGUE NUMBER	SYSTEM TYPE	Un [Vac]	Uc [V]	Iimp (10/350) [kA]	Imax (8/20) [kA]	In (8/20) [kA]	Up@In (8/20) [kV]	REMOTE (M)	Cartridge Id.	
										L	N
83120114	STPT12-12K275V-2PG	TT (1Ph+N)	230/-	275	12.5 (L-N) 25 (N-PE)	50	20	≤1.3 (L-N) ≤1.5 (N-PE)		C03	C06
83120115	STPT12-12K275V-2PGM	TT (1Ph+N)	230/-	275	12.5 (L-N) 25 (N-PE)	50	20	≤1.3 (L-N) ≤1.5 (N-PE)	√	C03	C06
83120120	STPT12-12K275V-2P	TNS (1Ph+N)	230/-	275	12.5	50	20	≤1.3		C03	
83120121	STPT12-12K275V-2PM	TNS (1Ph+N)	230/-	275	12.5	50	20	≤1.3	√	C03	

ELV Extra Low Voltage, also for use in DC Photovoltaic self-consumption / off-grid applications.

3 poles

REFERENCE NUMBER	CATALOGUE NUMBER	SYSTEM TYPE	Un [Vac]	Uc [V]	Iimp (10/350) [kA]	Imax (8/20) [kA]	In (8/20) [kA]	Up@In (8/20) [kV]	REMOTE (M)	Cartridge Id.	
										L	N
83120130	STPT12-12K275V-3P	TNC (3Ph)	-/400	275	12.5	50	20	≤1.3		C03	-
83120131	STPT12-12K275V-3PM	TNC (3Ph)	-/400	275	12.5	50	20	≤1.3	√	C03	-

4 poles

REFERENCE NUMBER	CATALOGUE NUMBER	SYSTEM TYPE	Un [Vac]	Uc [V]	Iimp (10/350) [kA]	Imax (8/20) [kA]	In (8/20) [kA]	Up@In (8/20) [kV]	REMOTE (M)	Cartridge Id.	
										L	N
83120138	STPT12-12K275V-4PG	TT (3Ph+N)	230/400	275	12.5 (L-N) 50 (N-PE)	50	20	≤1.3 (L-N) ≤1.5 (N-PE)		C03	C07
83120139	STPT12-12K275V-4PGM	TT (3Ph+N)	230/400	275	12.5 (L-N) 50 (N-PE)	50	20	≤1.3 (L-N) ≤1.5 (N-PE)	√	C03	C07
83120144	STPT12-12K275V-4P	TNS (3Ph+N)	230/400	275	12.5	50	20	≤1.3		C03	
83120145	STPT12-12K275V-4PM	TNS (3Ph+N)	230/400	275	12.5	50	20	≤1.3	√	C03	

Replacement cartridges

REFERENCE NUMBER	CATALOGUE NUMBER	NETWORK	Un [Vac]	Uc [V]	Iimp (10/350) [kA]	Imax (8/20) [kA]	In (8/20) [kA]	Up@In (8/20) [kV]	CARTRIDGE ID.
83120002	SP12-12K275V	L-N (1Ph)	230	275	12.5	50	20	≤1.3	C03
83120005	SP12-25K-N	N-PE (N)	Neutral	255	25	50	25	≤1.5	C06
83120006	SP12-50K-N	N-PE (N)	Neutral	255	50	50	50	≤1.5	C07

SURGE-TRAP® TYPE 1+2 SPDs | STP T12 25

STP T12 25

Dimensions

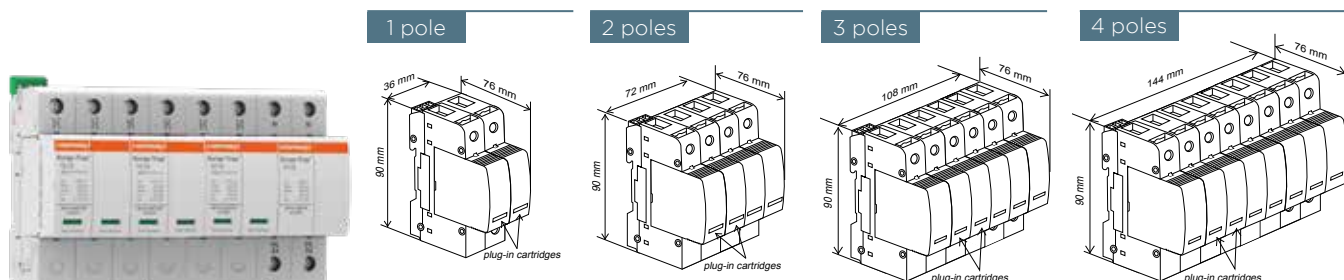

Catalogue numbers / Reference numbers

1 pole

REFERENCE NUMBER	CATALOGUE NUMBER	SYSTEM TYPE	Un [Vac]	Uc [V]	Iimp (10/350) [kA]	Imax (8/20) [kA]	In (8/20) [kA]	Up [kV]	REMOTE (M)	Cartridge Id.	
										L	N
83120152	STPT12-25K275V-1P	L-N (1Ph)	230	275	25	100	25	≤ 1,5		C65	
83120153	STPT12-25K275V-1PM	L-N (1Ph)	230	275	25	100	25	≤ 1,5	√	C65	
83120166	STPT12-100K-N	N-PE (N)	Neutral	255	100	100	50	≤ 1,5			C66

2 poles

REFERENCE NUMBER	CATALOGUE NUMBER	SYSTEM TYPE	Un [Vac]	Uc [V]	Iimp (10/350) [kA]	Imax (8/20) [kA]	In (8/20) [kA]	Up [kV]	REMOTE (M)	Cartridge Id.	
										L	N
83120156	STPT12-25K275V-2P	TNS (1Ph+N)	230 / -	275	25	100	25	≤ 1,5		C65	
83120157	STPT12-25K275V-2PM	TNS (1Ph+N)	230 / -	275	25	100	25	≤ 1,5	√	C65	
83120154	STPT12-25K275V-2PG	TT (1Ph+N)	230 / -	275	25	100	25	≤ 1,5		C65	C67
83120155	STPT12-25K275V-2PGM	TT (1Ph+N)	230 / -	275	25	100	25	≤ 1,5	√	C65	C67

3 poles

REFERENCE NUMBER	CATALOGUE NUMBER	SYSTEM TYPE	Un [Vac]	Uc [V]	Iimp (10/350) [kA]	Imax (8/20) [kA]	In (8/20) [kA]	Up [kV]	REMOTE (M)	Cartridge Id.	
										L	N
83120158	STPT12-25K275V-3P	TNC (3Ph)	- / 400	275	25	100	25	≤ 1,5		C65	
83120159	STPT12-25K275V-3PM	TNC (3Ph)	- / 400	275	25	100	25	≤ 1,5	√	C65	

4 poles

REFERENCE NUMBER	CATALOGUE NUMBER	SYSTEM TYPE	Un [Vac]	Uc [V]	Iimp (10/350) [kA]	Imax (8/20) [kA]	In (8/20) [kA]	Up [kV]	REMOTE (M)	Cartridge Id.	
										L	N
83120160	STPT12-25K275V-4P	TNS (3Ph+N)	230 / 400	275	25	100	25	≤ 1,5		C65	
83120161	STPT12-25K275V-4PM	TNS (3Ph+N)	230 / 400	275	25	100	25	≤ 1,5	√	C65	
83120150	STPT12-25K275V-4PG	TT (3Ph+N)	230 / 400	275	25	100	25	≤ 1,5		C65	C66
83120151	STPT12-25K275V-4PGM	TT (3Ph+N)	230 / 400	275	25	100	25	≤ 1,5	√	C65	C66

Replacement cartridges

REFERENCE NUMBER	CATALOGUE NUMBER	NETWORK	Un [Vac]	Uc [V]	Iimp (10/350) [kA]	Imax (8/20) [kA]	In (8/20) [kA]	Up [kV]	CARTRIDGE ID.
83120007	SP12-25K275V	L-N (1Ph)	230	275	25	100	25	≤ 1,5	C65
83120009	SP12-50K-2PN	N-PE (N)	Neutral	255	50	100	25	≤ 1,5	C66
83120008	SP12-100K-N	N-PE (N)	Neutral	255	100	100	50	≤ 1,5	C67

SURGE-TRAP® TYPE 2 SPDs | STP T2 40

STP T2 40

Dimensions

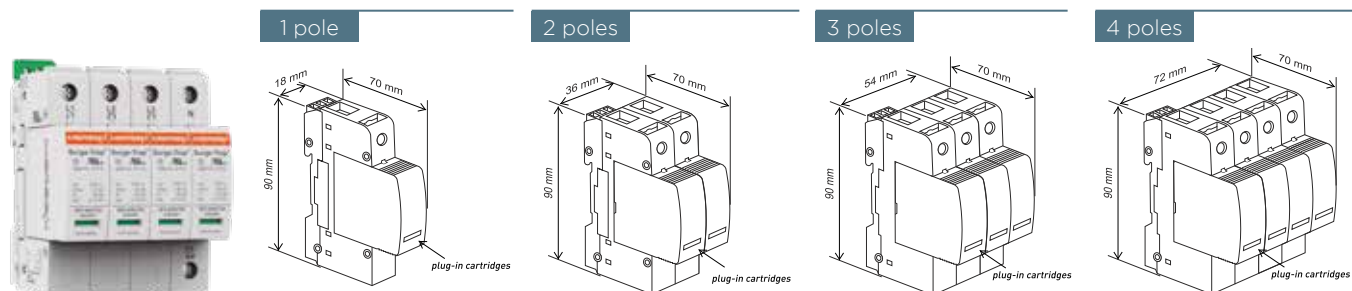

Catalogue numbers / Reference numbers

1 pole

REFERENCE NUMBER	CATALOGUE NUMBER	SYSTEM TYPE	Un [VAC]	Uc [V]	Imax (8/20) [kA]	In (8/20) [kA]	Up@In (8/20) [kV]	REMOTE (M)	Cartridge Id.	
									L	N
83020106	STPT2-40K275V-1P	L-N (1Ph)	230	275	40	20	≤1.3		C23	-
83020107	STPT2-40K275V-1PM	L-N (1Ph)	230	275	40	20	≤1.3	√	C23	-
83020112	STPT2-40K-N	N-PE (N)	Neutral	265	40	20	≤1.5		-	C27

2 poles

REFERENCE NUMBER	CATALOGUE NUMBER	SYSTEM TYPE	Un [VAC]	Uc [V]	Imax (8/20) [kA]	In (8/20) [kA]	Up@In (8/20) [kV]	REMOTE (M)	Cartridge Id.	
									L	N
83020116	STPT2-40K275V-2PG	TT (1Ph+N)	230/-	275	40	20	≤1.3 (L-N) ≤1.5 (N-PE)		C23	C27
83020117	STPT2-40K275V-2PGM	TT (1Ph+N)	230/-	275	40	20	≤1.3 (L-N) ≤1.5 (N-PE)	√	C23	C27
83020122	STPT2-40K275V-2P	TNS (1Ph+N)	230/-	275	40	20	≤1.3		C23	
83020123	STPT2-40K275V-2PM	TNS (1Ph+N)	230/-	275	40	20	≤1.3	√	C23	

ELV Extra Low Voltage, also for use in DC Photovoltaic self-consumption / off-grid applications.

3 poles

REFERENCE NUMBER	CATALOGUE NUMBER	SYSTEM TYPE	Un [VAC]	Uc [V]	Imax (8/20) [kA]	In (8/20) [kA]	Up@In (8/20) [kV]	REMOTE (M)	Cartridge Id.	
									L	N
83020134	STPT2-40K275V-3P	TNC (3Ph)	-/400	275	40	20	≤1.3		C23	-
83020135	STPT2-40K275V-3PM	TNC (3Ph)	-/400	275	40	20	≤1.3	√	C23	-

4 poles

REFERENCE NUMBER	CATALOGUE NUMBER	SYSTEM TYPE	Un [VAC]	Uc [V]	Imax (8/20) [kA]	In (8/20) [kA]	Up@In (8/20) [kV]	REMOTE (M)	Cartridge Id.	
									L	N
83020146	STPT2-40K275V-4PG	TT (3Ph+N)	230/400	275	40	20	≤1.3 (L-N) ≤1.5 (N-PE)		C23	C27
83020147	STPT2-40K275V-4PGM	TT (3Ph+N)	230/400	275	40	20	≤1.3 (L-N) ≤1.5 (N-PE)	√	C23	C27
83020152	STPT2-40K275V-4P	TNS (3Ph+N)	230/400	275	40	20	≤1.3		C23	
83020153	STPT2-40K275V-4PM	TNS (3Ph+N)	230/400	275	40	20	≤1.3	√	C23	

Replacement cartridges

REFERENCE NUMBER	CATALOGUE NUMBER	NETWORK	Un [VAC]	Uc [V]	Imax (8/20) [kA]	In (8/20) [kA]	Up@In (8/20) [kV]	CARTRIDGE ID.
83020002	SP2-40K275V	L-N (1Ph)	230	275	40	20	≤1.3	C23
83020000	SP2-40K-N	N-PE (N)	Neutral	265	40	20	≤1.5	C27

SURGE-TRAP® TYPE 2 SPDs | STP T2 40 TERRA

STP T2 40 - TERRA

Dimensions

2 poles

4 poles

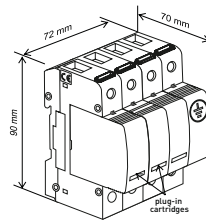
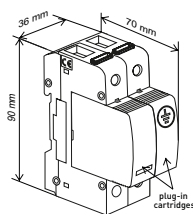

Catalogue numbers / Reference numbers

2 poles

REFERENCE NUMBER	CATALOGUE NUMBER	SYSTEM TYPE	Un [Vac]	Uc [V]	I _{max} (8/20) [kA]	I _n (8/20) [kA]	Up@In (8/20) [kV]	Cartridge Id.
83020183	STPT2-40K275V-2P-TE	TT (1Ph+N)	230	275	40	20	≤1.3	L C23

4 poles

REFERENCE NUMBER	CATALOGUE NUMBER	SYSTEM TYPE	Un [Vac]	Uc [V]	I _{max} (8/20) [kA]	I _n (8/20) [kA]	Up@In (8/20) [kV]	Cartridge Id.
83020185	STPT2-40K275V-4P-TE	TT (3Ph+N)	230/400	275	40	20	≤1.3 (L-N) ≤1.5 (N-PE)	L C23

Replacement cartridges

REFERENCE NUMBER	CATALOGUE NUMBER	NETWORK	Un [VAC]	Uc [V]	I _{max} (8/20) [kA]	I _n (8/20) [kA]	Up@In (8/20) [kV]	CARTRIDGE ID.
83020002	SP2-40K275V	L-N (1Ph)	230	275	40	20	≤1.3	C23

SURGE-TRAP® TYPE 2+3 SPDs | STP T23 20

STP T23 20

Dimensions

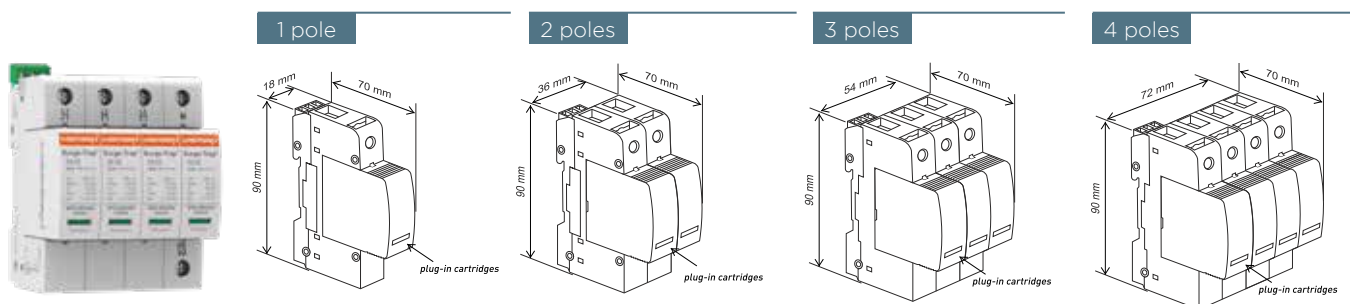

Catalogue numbers / Reference numbers

1 pole

REFERENCE NUMBER	CATALOGUE NUMBER	SYSTEM TYPE	Un [Vac]	Uc [V]	Imax (8/20) [kA]	In (8/20) [kA]	Uoc [kV]	Up@In (8/20) [kV]	REMOTE (M)	Cartridge Id.	
										L	N
83230102	STPT23-20K320V-1P	L-N (1Ph)	230; 277	320	20	10	10	≤1.4		C62	-
83230103	STPT23-20K320V-1PM	L-N (1Ph)	230; 277	320	20	10	10	≤1.4	√	C62	-

2 poles

REFERENCE NUMBER	CATALOGUE NUMBER	SYSTEM TYPE	Un [Vac]	Uc [V]	Imax (8/20) [kA]	In (8/20) [kA]	Uoc [kV]	Up@In (8/20) [kV]	REMOTE (M)	Cartridge Id.	
										L	N
83230112	STPT23-20K320V-2PG	TT (1Ph+N)	230/-; 277/-	320	20	10	10	≤1.4 (L-N) ≤1.5 (N-PE)		C62	C64
83230113	STPT23-20K320V-2PGM	TT (1Ph+N)	230/-; 277/-	320	20	10	10	≤1.4 (L-N) ≤1.5 (N-PE)	√	C62	C64
83230116	STPT23-20K320V-2P	TNS (1Ph+N)	230/-; 277/-	320	20	10	10	≤1.4		C62	
83230117	STPT23-20K320V-2PM	TNS (1Ph+N)	230/-; 277/-	320	20	10	10	≤1.4	√	C62	

3 poles

REFERENCE NUMBER	CATALOGUE NUMBER	SYSTEM TYPE	Un [Vac]	Uc [V]	Imax (8/20) [kA]	In (8/20) [kA]	Uoc [kV]	Up@In (8/20) [kV]	REMOTE (M)	Cartridge Id.	
										L	N
83230122	STPT23-20K320V-3P	TNC (3Ph)	-/400; -/480	320	20	10	10	≤1.4		C62	-
83230123	STPT23-20K320V-3PM	TNC (3Ph)	-/400; -/480	320	20	10	10	≤1.4	√	C62	-

4 poles

REFERENCE NUMBER	CATALOGUE NUMBER	SYSTEM TYPE	Un [Vac]	Uc [V]	Imax (8/20) [kA]	In (8/20) [kA]	Uoc [kV]	Up@In (8/20) [kV]	REMOTE (M)	Cartridge Id.	
										L	N
83230128	STPT23-20K320V-4PG	TT (3Ph+N)	230/400; 277/480	320	20	10	10	≤1.4 (L-N) ≤1.5 (N-PE)		C62	C64
83230129	STPT23-20K320V-4PGM	TT (3Ph+N)	230/400; 277/480	320	20	10	10	≤1.4 (L-N) ≤1.5 (N-PE)	√	C62	C64

Replacement cartridges

REFERENCE NUMBER	CATALOGUE NUMBER	NETWORK	Un [Vac]	Uc [V]	Imax (8/20) [kA]	In (8/20) [kA]	Uoc [kV]	Up@In (8/20) [kV]	CARTRIDGE ID.
83230002	SP23-20K320V	L-N (1Ph)	230; 277	320	20	10	10	≤1.4	C62

SURGE-TRAP® TYPE 2+3 SPDs

STM T23 20 S

Dimensions

2 poles

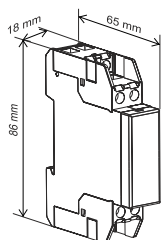

Catalogue numbers / Reference numbers

2 poles

REFERENCE NUMBER	CATALOGUE NUMBER	SYSTEM TYPE	Un [Vac]	Uc [V]	I _{max} (8/20) [kA]	In (8/20) [kA]	Uoc [kV]	Up@In (8/20) [kV]	REMOTE (M)
83230510	STMT23-20K275V-SP-S	TT/TNS (1Ph+N)	230	275	20	10	10	≤1.4 [L1-L2] 1.4 [L1/L2-PE]	
83230511	STMT23-20K275V-SP-SM	TT/TNS (1Ph+N)	230	275	20	10	10	≤1.4 [L1-L2] 1.4 [L1/L2-PE]	√

STE T23 20

Dimensions

2 poles

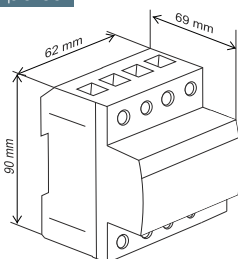

Catalogue numbers / Reference numbers

2 poles

REFERENCE NUMBER	CATALOGUE NUMBER	SYSTEM TYPE	Un [Vac]	Uc [V]	I _{max} (8/20) [kA]	In (8/20) [kA]	Uoc [kV]	Up@In [kV]	IL [A]	REMOTE (M)
83230403	STET23-20K275V-SPM	TT/TNS (1Ph+N)	230	275	20	10	6	≤1.2	20	√

SELECTION GUIDE

First Stage of Surge Protection

Service Entrance - Generally in the main switchboard

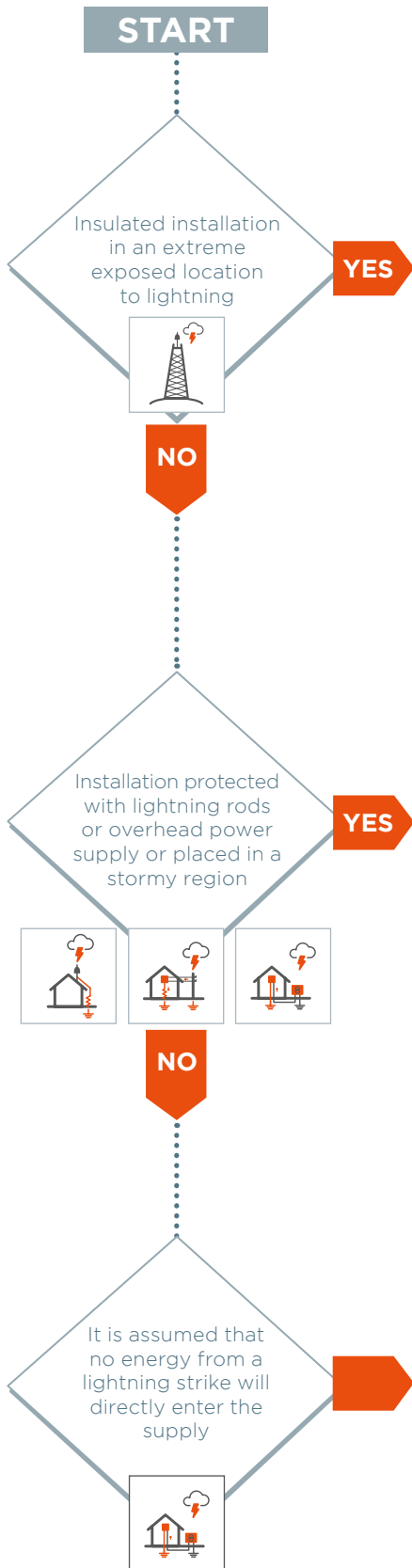

MAIN SWITCHBOARD

STPT12 - 25kA

Conducted Lightning Energy

Worst case as per IEC 61643

USE limp 25kA (10/350µs waveform)

NETWORK		TYPE 1+2 limp 25kA
		CATALOGUE NUMBER
Single	TT (1 Ph+N)	STPT12-25K275V-2PGM
Phase	TNS (1 Ph+N)	STPT12-25K275V-2PM
Three	TT (3 Ph+N)	STPT12-25K275V-4PGM
Phase	TNS (3 Ph+N)	STPT12-25K275V-4PM

PARAMETERS PER RANGE	
limp	25kA
I _{typ}	200 x @ 20kA
I _{max}	100kA
I _n	20kA
U _p	< 1.3 kV

STPT12 - 12.5kA

Conducted Lightning Energy

Normal case as per IEC 61643

USE limp 12.5kA (10/350µs waveform)

NETWORK		TYPE 1+2 limp 12.5kA
		CATALOGUE NUMBER
Single	TT (1 Ph+N)	STPT12-12K275V-2PGM
Phase	TNS (1 Ph+N)	STPT12-12K275V-2PM
Three	TT (3 Ph+N)	STPT12-12K275V-4PGM
Phase	TNS (3 Ph+N)	STPT12-12K275V-4PM

PARAMETERS PER RANGE	
limp	12.5kA
I _{typ}	100 x @ 20kA
I _{max}	50kA
I _n	20kA
U _p	< 1.3 kV

STPT2 - 40kA

Induced Surge Events

- Supply Network switching
- Inductive/Capacitive loads

USE I_{max} 40kA (8/20µs waveform)

NETWORK		TYPE 2 I _{max} 40kA
		CATALOGUE NUMBER
Single	TT (1 Ph+N)	STPT2-40K275V-2PGM
Phase	TNS (1 Ph+N)	STPT2-40K275V-2PM
Three	TT (3 Ph+N)	STPT2-40K275V-4PGM
Phase	TNS (3 Ph+N)	STPT2-40K275V-4PM

* Replace IR with SG for inbuilt earth loop impedance monitoring

PARAMETERS PER RANGE	
I _{max}	40kA
I _{typ}	500 x @ 5kA
I _n	20kA
U _p	< 1.3 kV

Second Stage of Surge Protection
Generally, in the distribution board

DISTRIBUTION SWITCHBOARD

STPT2 - 40kA

NETWORK		TYPE 2 I _{max} 40kA
		CATALOGUE NUMBER
Single	TT (1 Ph+N)	STPT2-40K275V-2PGM
Phase	TNS (1 Ph+N)	STPT2-40K275V-2PM
Three	TT (3 Ph+N)	STPT2-40K275V-4PGM
Phase	TNS (3 Ph+N)	STPT2-40K275V-4PM

* Replace IR with SG for inbuilt earth loop impedance monitoring

PARAMETERS PER RANGE	
I _{max}	40kA
I _n	20kA
U _p	< 1.3 kV
I _{typ}	500 x @ 5kA



Upgrade the STPT2 range to STPT2 TERRA to monitor the earth connection critical to provide a path to direct surge energy.

ST TERRA
TYPE 2 I_{max} 40kA SPD + EARTH MONITORING SYSTEM



NO CONNECTION

POOR

CORRECT

I_{max} 40kA (type 2)

EFFECTIVE SURGE PROTECTION

When the ST TERRA® LED is green, it indicates that the ground path is good enough to shunt the energy peaks to ground effectively.

CONFIRMATION OF PROPPER INSTALLATION

When the ST TERRA® LED is green, it indicates that the protection device is properly wired and powered up.

SAFETY INFORMATION IN THE EVENT OF INDIRECT CONTACT

When the ST TERRA® cannot detect any ground connection, it is advisable to check the installation status.

STPT23 - 20kA

NETWORK		TYPE 2 I _{max} 20kA
		CATALOGUE NUMBER
Single	TT (1 Ph+N)	STPT23-20K320V-2PGM
Phase	TNS (1 Ph+N)	STPT23-20K320V-2PM
Three	TT (3 Ph+N)	STPT23-20K320V-4PGM
Phase	TNS (3 Ph+N)	STPT23-20K320V-4PM

* Replace IR with SG for inbuilt earth loop impedance monitoring

PARAMETERS PER RANGE	
I _{max}	20kA
I _n	10kA
U _p	< 1.3 kV
I _{typ}	500 x @ 5kA



For other voltages, please contact MERSEN.

SPD GENERAL INSTALLATION FEATURES

Recommended lengths and connection types according to 61643-12

In order to achieve optimum overvoltage protection, connecting conductors of SPDs shall be as short as possible. Long lead lengths will degrade the protection offered by the SPD.

When connecting an SPD in parallel, the optimal connection is a “V-type” (see image below). Whenever this is not feasible, the maximum derivation cable length should be less than 0.5m.

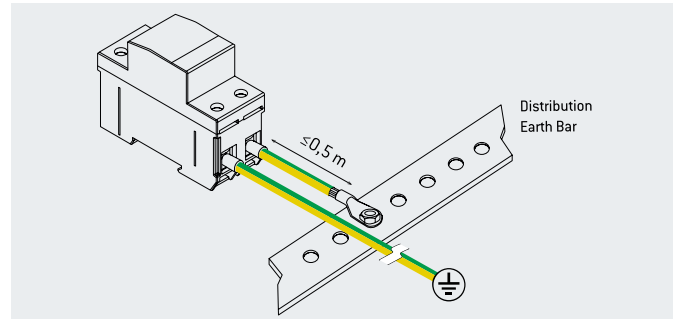

Wiring, general considerations (lengths and sections)

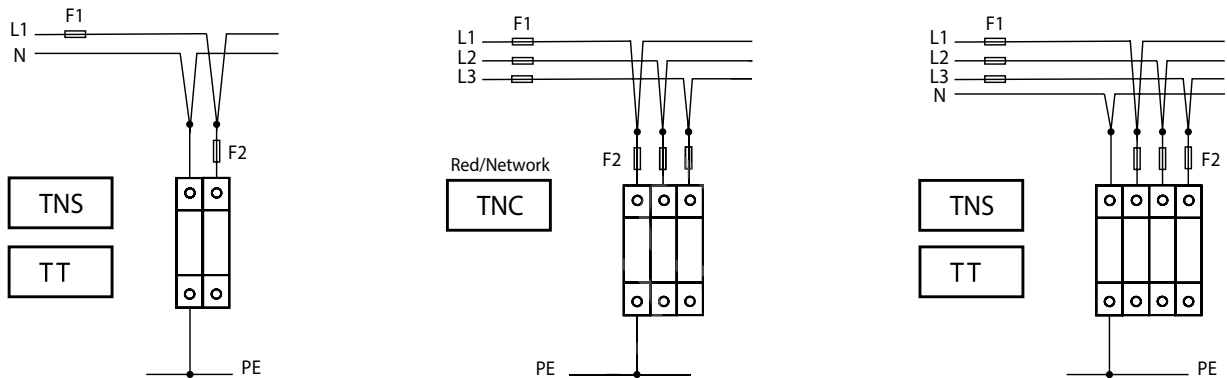

TYPE OF WIRE	STRANDED	RIGID
Ø min. L,N,PE	6 mm ²	
Ø max. L,N,PE	25 mm ²	35 mm ²

Remote Indication

U _{max} / I _{max}		
	AC:	50V/1A
	DC:	125V/0,2A

When do we have to install a back-up fuse or circuit breaker?*

RANGE		MAXIMUM BACK-UP RATING ACCORDING TO MANUFACTURER		BACK-UP FUSE RECOMMENDED IN IEC61643
STP T12 25	Limp 25 kA	If F1 > 315 A then ↓ F2 ≤ 315 A	If F1 ≤ 315 A then ↓ F2 not required	250 A gG
STP T12 12.5	Limp 12.5 kA	F1 > 200 A ↓ F2 ≤ 200 A	If F1 ≤ 200 A then ↓ F2 not required	160 A gG
STP T2 40	I _{max} 40 kA	F1 > 250 A ↓ F2 ≤ 125 A	If F1 ≤ 250 A then ↓ F2 not required	100 A gG
STP T2 20	I _{max} 20 kA	F1 > 80 A ↓ F2 ≤ 80 A	If F1 ≤ 80 A then ↓ F2 not required	63 A gG

* If the main circuit breaker has a rating less than the maximum required by the SPD, then additional protection is not required.

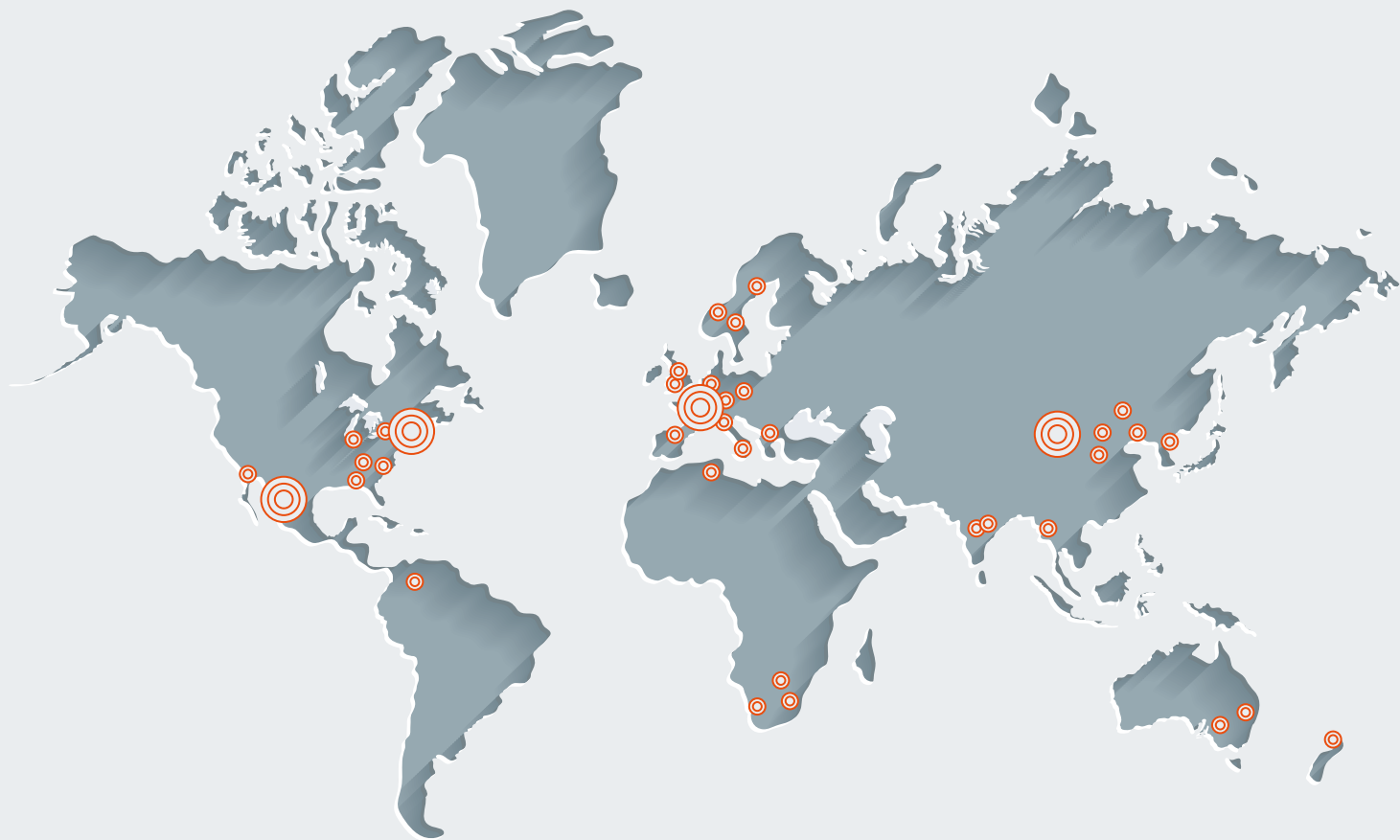

GLOBAL EXPERT
IN ELECTRICAL POWER
AND ADVANCED MATERIALS

EUROPE

UK
MERSEN UK
Unit 12, Tungsten Building, George Street-
Portslade, East Sussex BN41 1RA
+ 44 (0)1273 425119
sales.ep.uk@mersen.com



EP.MERSEN.COM